



JACKSON GRILLS INC.
#106-2480 Mt. Lehman Rd.
Abbotsford, BC V4X 2N3
E-Mail: support@jacksongrills.com
WEB: www.jacksongrills.com
TEL: 1 (888) 287-3333
FAX: 1 (877) 855-5373

OWNER'S MANUAL:

Premier Model: JPG700 Cart Style Gas Grill

The Ultimate Premier Series



FOR OUTDOOR USE ONLY

!WARNING!

If you smell gas:

1. Shut off gas to the appliance.
2. Extinguish any open flame.
3. Open lid.
4. If odor continues, keep away from appliance and immediately call your gas supplier & fire department.

!WARNING!

1. Do not store or use gasoline or other flammable liquids in the vicinity of this appliance.
2. Do not store disconnected propane tanks in the vicinity of this appliance.

Version: Jan.13



TABLE OF CONTENTS

Table of Contents:	2
Safety Warnings:	3
Certification & Testing;	4
Unpacking Your Grill; Parts Checklist	4
Special Message to Owners:	5
Owner Registration:	5
Tools Required for Assembly:	6
Assembling & Preparing your Grill:	6-8
Propane Gas Connection:	9-10
Leak Testing:	11
Installer Final Checklist:	12
Fuel Conversions:	12
Lighting Instructions:	13
Grill, Rotisserie and Side Burner Cooking	14-15
Cleaning & Maintenance:	16-18
Storing your Grill:	18
Trouble Shooting:	19
Exploded Parts View:	20
Parts List:	21
Warranty:	22

!SAFETY WARNINGS!

SAFETY FIRST:

Please read and understand all warnings and precautions prior to operating your gas grill.

- 1 This grill is for outside use only, and shall not be used in any building, garage, enclosed area or vehicle.
- 2 This grill is set up from the factory for use with Propane Gas (LP). (Propane Cylinder /Tank not included)
- 3 Do not use gasoline, alcohol or other volatiles for lighting!
- 4 The Propane (LP) gas supply cylinder must be constructed and marked in accordance with the specifications for propane gas cylinders of the US Department of transport (DOT) CFR 49 or the National Standards of Canada, CAN/CSA B339, Cylinders, Spheres and Tubes for the Transportation of Dangerous Goods.
- 5 Always open the grill lid slowly & carefully as heat and steam in the grill can cause severe burns.
- 6 Always place your grill on a hard level surface away from combustible materials
- 7 Do not attempt to move this grill while lit.
- 8 Do not leave a lit grill unattended. Keep children and pets away from this grill at all times.
- 9 Do not use this grill unless it is COMPLETELY assembled and all parts are securely installed.
- 10 To prevent liquid propane from entering the regulator valve and causing a possible hazard, please ensure that the propane cylinder is at a lower level than the regulator valve/regulator when in use.
- 11 Keep grill area clear and free from combustibles and gasoline or other flammable vapors and liquids.
- 12 Do not alter this grill in any manner.
- 13 Do not touch any metal surfaces on this grill until it has completely cooled to avoid burns, unless wearing protective gear. (Pot holders, gloves, BBQ mittens, etc.)
- 14 It is essential to keep the valve compartment, burners, and circulating air passages clean and free of obstructions and debris. Inspect the grill before each use.
- 15 Do not store any spare propane cylinders within 10 feet of this Portable Grill.
- 16 Please note that propane (LP) is explosive under pressure, heavier than air, and settles and pools in low areas, which can create an explosion hazard.
- 17 Contact with propane gas can cause freeze burns to your skin.
- 18 Dented and rusted propane cylinders may be hazardous and should be checked by a propane gas supplier, before use.
- 19 This grill is equipped with a three-prong (grounding) plug for your protection, and should be plugged into a grounded three-prong receptacle. Do not cut or remove the ground prong.
- 20 Keep electrical supply cords away from any heated surfaces.

!WARNING!
Failure to follow all manufacturer's instructions could result in serious bodily injury and/or property damage.

CERTIFICATION & TESTING

This appliance has been tested by Labtest Certification (LC) and has been tested to ANSI Z21.58a-1198 & CGA 16a-M98, and Certified for Canada and the USA.

NOTE: The use and installation of this product must conform to local codes. In the absence of local codes, use the National Fuel and Gas Code, ANSI A223.1, Storage and Handling of Liquefied Petroleum Gasses, NFPA / ANSI 58.

UNPACKAGING YOUR GRILL

The JPG700 Cart Model comes packaged in two boxes. Please open each box carefully and set aside all loose components. Once unpacked, match the parts to the list shown below. Check all components for possible damage before assembling your grill. Most of your however there are still some items that position in your barbecue. For assembly **Assembling & Preparing Your Grill.**



portable grill has been factory assembled, must be unpacked, and placed in the correct instructions please refer to the next Section;

!WARNING!

Exercise caution when handling stainless steel; metal edges may be sharp and can cause injury.

!TECH-TIP!

Do not throw away packaging until you have confirmed that all parts are present.

PARTS CHECKLIST:

- 1 x Main Firebox Assembly with Pedestal
- 1 x Warming Rack
- 4 x Flame Diffusers
- 2 x Cook Grids
- 1 x Full Length Cover
- 1 x Grease Cup
- 1 x Complete Rotisserie Kit w/ Flex Light
- 1 x AA Battery for Rotisserie Ignition
- 1 x LH Side Shelf with Side Burner
- 1 x RH Side Shelf
- 1 x Owner's Manual

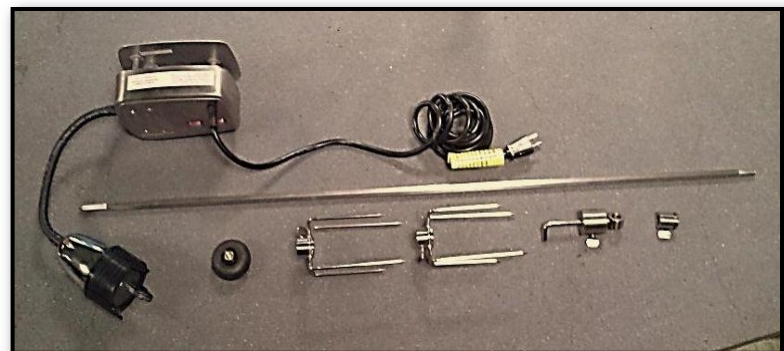

Shown: Rotisserie Kit Components

Propane Models:

- 1 x Propane (LP) Hose & Regulator

Natural Gas Models:

- 1 x Natural Gas Hose with Quick Release

Special Message for our Customers

All of us at Jackson thank you, for choosing a Jackson grill! This appliance was designed, engineered, and built with quality components and we are confident that it will provide you with years of excellent operation.

Please take the time to read the entire manual and familiarize yourself with all of the features of the Jackson Grill. This manual also contains important safety information and operation instructions. Please write your barbecue's serial number in the space below, and ensure that this manual remains handy to the barbeque for quick reference.

To obtain replacement parts for your Jackson Grill, contact your local dealer. If you have any questions please call us anytime at the number below: (Please have your model and serial number at hand)

Grill Model: **JPG700**

***Serial Number:** _____

*write your serial number here for future reference.

OWNER REGISTRATION: Please take the time to fill out and return a Warranty Registration Card. This can be done on-line at www.jacksongrills.com, or simply fill in the form below and mail or fax to:

Jackson Grills Inc.
#106-2480 Mt. Lehman Rd.
Abbotsford, BC
Canada, V4X 2N3

Fax: 1 (877) 855-5373

Customer Service: 1 (888) 287-3333

Please complete and return within 10 days. Thank you.

Title: Mr. Mrs. Ms. Miss (Circle One)

First Name: _____ Initial: _____ Last Name: _____

Street: _____ Apt. #: _____

City: _____ State/Prov.: _____ Zip/Postal: _____

Phone: _____ Email: _____

Date Purchased: _____ Dealer: _____

Model: _____ Serial #: _____

Comments: _____

Thank you for taking the time to fill out this Ownership and Registration Card

Dear Grill Owner; please keep this manual for future reference.

Tools Required for Assembly*:

*Please use the proper tools to simplify installation and prevent personal injury or damage to your grill.

A) Installer Supplied Tools:

- 1 x Medium Phillips Screwdriver
- 1 x 5/16" Wrench (or 8mm)
- 2 x 3/4" Wrench (or 19mm)



Assembling & Preparing Your Grill:

B) Install Flame Diffusers, Cook Grids and Warming Rack:

1. Remove the flame diffusers from the packaging. Please ensure that all protective plastic has been removed.
2. Install the diffusers directly above each burner, by slotting them onto the small pins on the front and rear wall of the firebox (Fig. 1). Please ensure that the diffusers sit down correctly in their slots, to optimize diffuser function.
3. Install 2 X Cook Grids on the upper ledges of the firebox (Fig. 2)

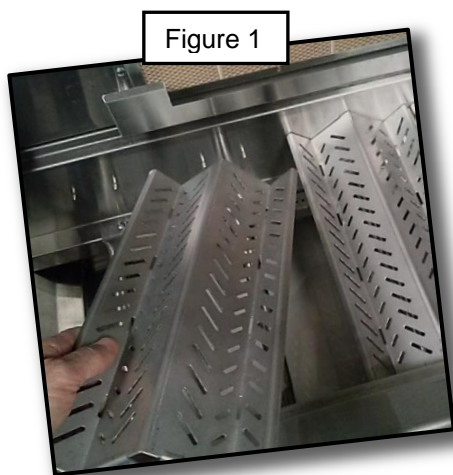

Figure 1



Figure 2

4. Remove warming rack from packaging and install above cooking grids on the 2 side brackets (or ledges) on the inner hood.

C) Rear Burner Spark Igniter:

1. Unscrew the plastic/rubber cap from the rear burner ignition module.
2. Insert the supplied AA battery with the positive end facing out. (Fig. 3)
3. Re-install cap.
4. To test the Igniter; push the Igniter button and hold. The ticking noise from the electrode indicates that the Spark Ignition is working fine!

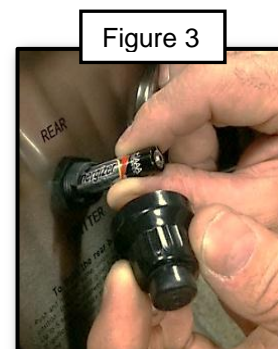
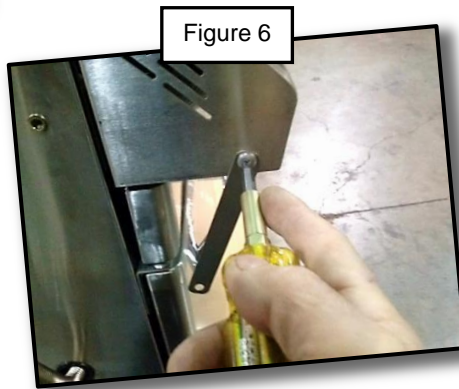
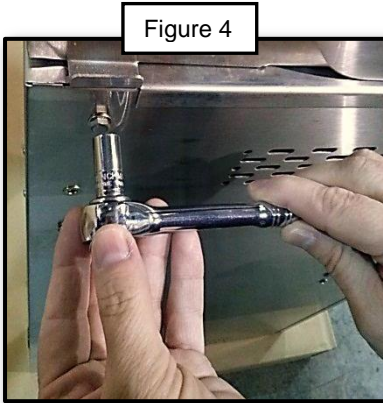

Figure 3

D) Side Burner/Side Shelf Installation:

1. Carefully remove the rotisserie kit parts and the side burner assembly from the packaging.
2. Loosen two 5/16" nuts on LH side of pedestal and turn out two full revolutions. (Fig. 4)
3. Remove 5 x Phillips screws (4 on the side panel and one on the side of the console; Fig. 5 & 6). Discard the temporary console hold down strap. Screws must be retained for installing the side burner.



4. Install Side Burner onto LH side of grill, by capturing the two 5/16" bolts that were loosened earlier. The two bolts fit into 'keyhole slots' located on the RH lip of the Side Burner.
5. While the Side Burner is hanging in place, re-install and tighten the 5 Philips screws removed earlier (Fig. 7).
6. Tighten the two bolts previously backed off two revolutions (Fig. 8). (NOTE; do not over-tighten; breakage risk!)

!TECH-TIP!
Apply anti-seize grease to the threads of any screw or bolt before reinstalling, This will greatly simplify future service work.

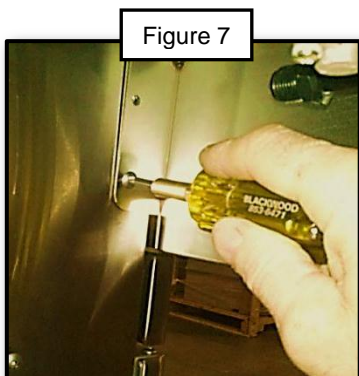

- Next, bend the flex fuel inlet line into a gentle "S" and thread it onto the Fuel Manifold under the Side Burner. Tighten using 2 x 3/4" (or 2 x 19mm) wrenches (Fig. 9; NOTE: Sealant NOT required at this connection).

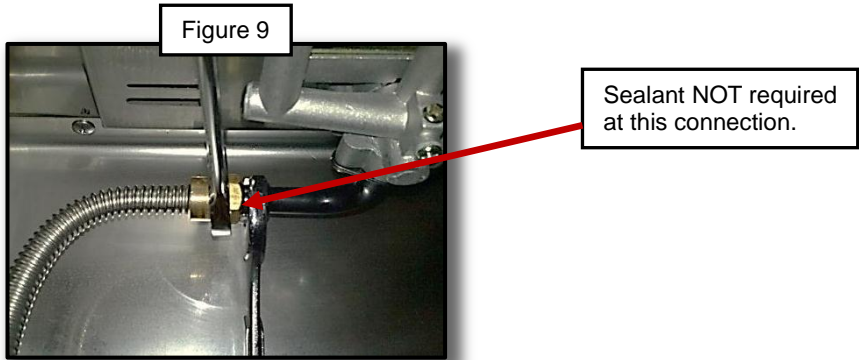

E) Rotisserie Kit Installation:

- Slide the Rotisserie Motor onto the Motor Mount Bracket, on the RH side of the grill (Fig. 10).

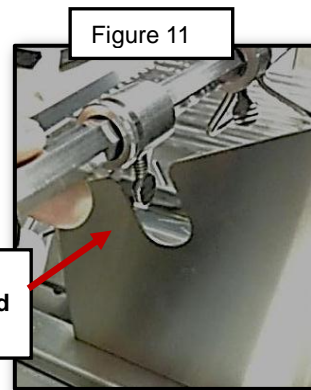
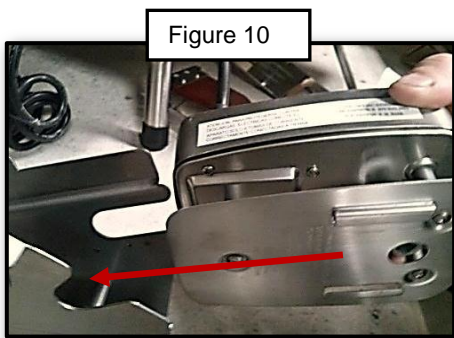

- Slide the two forks and the counter balancer onto the spit rod, and position as desired. Tighten in place.
- Place the rotisserie rod into the motor. Slide the rotisserie rod bushing over the opposite end of the rod and drop into the cut-out provided in the RH side of the inner hood. Once in place, tighten the thumb-screw on the spit rod bushing. (Fig. 12)

Rotisserie Kit installed and ready to go!

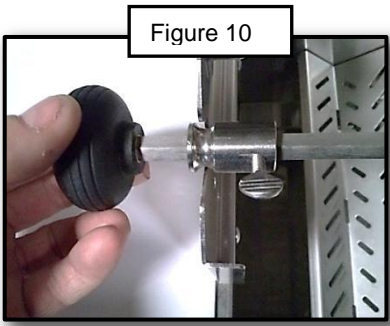

Propane Gas Connection:

- **Fuel Source:** This is a Propane (or LP = Liquid Propane) configured grill. Do not attempt to use a natural gas supply unless the grill has been converted to natural gas use.
- **Hose & Regulator:** Use only the propane hose and regulator supplied with this grill.
- **Installation Codes:** The installation of this appliance must conform with local codes or, in the absence of local codes, with the National Fuel Gas Code, ANSI Z223. 1, or CAN/CGA-B149.2 Propane Installation Code.
- **Propane Cylinder Requirements & Specifications:**
 1. Maximum Cylinder Size: 20 lbs. (9 Kg)
 2. Measurement: (approximately) Diameter: 12”(30.5cm) X Height: 18” (45.7cm):
 3. USA: All LP cylinders used with this grill must be constructed and marked in accordance with the *Specifications for LP (Propane) Gas Cylinders* of the US Department of Transportation (D.O.T.). Refer to your propane cylinder collar for markings.
 4. CANADA: All propane cylinders used with this grill must be constructed and marked in accordance with the National Standard of Canada, CAN/CSA-B339; *Cylinders, Spheres and Tubes for the Transportation of Dangerous Goods and Commission*. Refer to your propane cylinder collar for markings.
 5. Cylinder supply system must be arranged for vapor withdrawal.
 6. Cylinder must be equipped with a collar to protect the outlet valve.
 7. Cylinders must be rust and dent free: a dented or rusty propane cylinder may be hazardous, and must be professionally inspected before use.
 8. Cylinders must be equipped with QCC Type 1 (Quick Closing Coupling) outlet, compatible with the regulator supplied.
 9. Propane Cylinders must be equipped with a safety relief valve.
 10. UL listed Overfill Protection Device (OPD), This OPD safety feature is identified by a unique triangular hand wheel. **Only use cylinders equipped with this type of valve. (See photo below)**



- **Propane Cylinder Handling:**
 1. Government regulations prohibit shipping full Propane cylinders. You must take your new cylinder to a Propane filling station for filling.
 2. A full cylinder is under high pressure; always handle with care, and transport secured and in an upright position. Protect the valve from accidental damage.
 3. Do not tip the propane cylinder while connecting it to your grill's regulator
 4. If the cylinder is tipped over while connected to your grill, shut it off and disconnect it; then have it checked before use.

■ **Propane Cylinder Storage:**

1. Disconnected propane cylinders must have a dust cap installed for storage purposes.
2. Store all propane cylinders outdoors in a well-ventilated area.
3. Do not store cylinders in direct sunlight or near a source of heat or combustion.
4. Propane cylinders must be REMOVED from your grill; when the grill is to be stored indoors.
5. Keep all propane tanks out of reach of children.
6. If your grill is stored outside, the propane tank may be left connected to the grill. Turn off propane tank valve when grill is not in use.

■ **Connecting Your Grill to a Propane Cylinder:**

1. Make sure tank valve is in its full off position (turn clockwise to stop).
2. Check tank valve to ensure that is equipped with external (male) threads (i.e. QCC-1 type connector).
3. Make sure all burner knobs are in their off position.
4. Remove the protective dust cap from the cylinder valve. Always leave the dust cap looped on the cylinder, for use during storage of the cylinder.
5. Inspect valve connection port and regulator assembly. Look for any damage or debris. Remove any debris. Inspect hose for damage. Never attempt to use damaged or plugged cylinders. Contact your local propane gas dealer for repair.
6. When connecting the regulator assembly to the valve, hand tighten black plastic Quick Coupling Connector (QCC) nut clockwise to a positive stop. Do not use a wrench to tighten. Use of a wrench may damage quick coupling nut and result in a hazardous condition.
7. Open tank valve fully (counterclockwise). Use a soapy water solution to check all connections for leaks before attempting to light grill. If a leak is found, turn tank valve off and do not use grill until a local L.P. gas dealer can make repairs.

!WARNING!

- 1 Never insert any foreign objects in valve outlet, as this may cause leaks.**
- 2 Do NOT connect this grill to integral or unregulated Propane systems such as in a motor home or camper trailer.**
- 3 Do NOT use this grill until leak tests have been completed.**
- 4. If a gas leak is detected and cannot be stopped, call the fire department immediately.**

■ **Disconnecting a Propane Cylinder**

1. Turn all the grill knobs to off.
2. Turn the tank valve off fully (turn clockwise to stop).
3. Detach the regulator assembly from tank valve by turning the Quick Coupling Connector (QCC) nut counterclockwise.
4. Install the protective cap back onto the threads of the propane cylinder valve.

Leak Testing:

1. GENERAL:

Although all gas connections on the grill are leak tested at the factory prior to shipment, a complete gas tightness check must be performed at the installation site due to possible mishandling in shipment, or excessive pressure unknowingly being applied to the unit. Periodically check the whole system for leaks, or immediately check if the smell of gas is detected.

2. BEFORE TESTING:

- a) Make sure that all packing materials are removed from the grill and cart.
- b) Do not smoke while leak testing.
- c) Never leak test with an open flame.
- d) Make a soap solution with one part liquid detergent and one part water. Prepare a spray bottle, brush, or rag to apply the solution to the connections. For the initial leak test, make sure the propane cylinder is full.
- e) Grill must be leak tested outdoors in well-ventilated area, away from ignition sources such as gas fired or electrical appliances, and flammable materials.

3. TESTING PROCEDURES:

- a) Make sure all control knobs are in the "OFF" position.
- b) Make sure the regulator is connected to the propane cylinder tightly.
- c) Completely open propane cylinder valve by turning counter clockwise. If you hear a "POP" sound, turn gas off IMMEDIATELY, it indicates a heavy leak at the connection. Call your gas dealer or fire department.
- d) Check every connection from the propane cylinder or natural gas quick release, up to and including the connection to the manifold pipe assembly (the pipe that goes to the burner) by brushing or spraying the soapy solution on the connections.
- e) If soap bubbles appear, there is a leak. Turn off propane cylinder valve or natural gas quick release IMMEDIATELY and retighten connections, Open valve again, and recheck.
- f) Always close the propane cylinder valve after leak test by turning clockwise.
- g) Only those parts recommended by the manufacturer should be used on the grill. Substitution can void the warranty. Do not use the grill until all connections have been checked and do not leak.

4. LEAK TEST SAFETY TIPS:

- a) Always check for leaks after every propane cylinder change.
- b) Always check for leaks at every connection before use.(Including natural gas quick release hook up)
- c) If any grease or hot items fall on the valve, regulator, hose or any part that conveys gas, shut the gas off immediately, check the cause and rectify it. Then, perform a complete leak test before reusing the grill.



Installer Final Check List:

- At least 36" clearance maintained from combustible constructions to the sides and back of this grill.
- There is no unprotected combustible construction or materials above the grill.
- All internal packaging removed.
- When using Natural Gas; conversion kit must be installed.
- Burners are sitting properly on orifices.
- Knobs turn freely.
- For propane grills; the original equipment Jackson propane regulator and hose is used (pre-set for 11.0" water column).
- Grill connections & valves, plus fuel sources pressure and leak tested per instructions in this manual.
- Grill test fired, and all functions working and in good order.
- User informed of gas supply shut off valve location.
- Owner's manual given to grill user.

Introducing the ISLAND GRILLSTONE™ Check out this fabulous new way to enhance your cooking! Quarried from natural volcanic rock and then cut into slabs, it is the ideal accessory for grilling veggies, seafood, or marinated meats. Drops right onto your grill! # GRILLSTONESQ (14" x 14")

The *ISLAND GRILLSTONE* (Optional)



Natural Gas or Propane Conversion*:

This grill is convertible to Natural Gas or Propane use, with the installation of a Conversion Kit; please see numbers shown below. The kit should be installed by a qualified gas fitter. Please contact your local dealer for information.

Natural Gas Conversion Kit Part Number: JF-78

Propane Conversion Kit Part Number: JF-001

Grill Lighting Instructions:

1. BEFORE LIGHTING:

- a) Always inspect the gas supply hose before turning the gas "ON". If there is evidence of cuts, wear, or abrasion, it must be replaced before use. Use only a manufacturer approved replacement hose.
- b) Check all gas connections for leaks before each use. Do not light grill if gas odor is present.

2. TO LIGHT MAIN BURNERS OF THE GRILL:

- a) Read instructions before lighting.
- b) Open lid prior to lighting your grill.
- c) Turn all knobs to "OFF" then open the propane cylinder valve or the natural gas valve on your gas hook up. Always keep your face and body averted when lighting.
- d) Push in and rotate each control knob counter clockwise slowly, to the "HI" position. (When rotating the knob, rotate for a two second count: do NOT turn the knob rapidly) The built-in igniter will click and spark, thus lighting the torch light pilot flame, then the main burner. If the burner does not light IMMEDIATELY turn the knob to off and wait 5 minutes for gas to dispel and repeat the lighting procedure.
- e) Follow match lighting instructions if burner can't be lit after repeating 3-4 times.

3. TO LIGHT MAIN BURNERS with a MATCH or Barbecue Lighter: (Temporary Solution when Ignition is disabled)

- a) Read instructions before lighting.
- b) Open the lid during lighting.
- c) Turn all knobs to "OFF" then open the propane cylinder valve or the natural gas valve on your gas hook up. Always keep your face and body averted when lighting.
- d) A long stove match or BBQ lighter must be used to reach the burners.
- e) Do NOT drop a burning match into grill for lighting purposes.
- f) Push and turn the main burner knob to the "HI" position, then release.
- g) Light burner by match. Make sure the burner lights and stays lit.
- h) If necessary, call your dealer or the Jackson service line, for assistance with repairing your ignition system.

4. Flame Characteristics:

- a) Check for proper burner flame characteristics. Each burner is adjusted prior to shipment; however, variations in the local gas supply may take subtle necessary adjustments.
- b) Burner flames should be blue and stable. There should be no excessive noise, or flame lifting. If any of these conditions exist please call your Dealer. If the flame is yellow, it indicates insufficient air. If the flame is noisy and tends to lift away from the burner, it indicates too much air.
- c) NOTE: small yellow tips are okay.

5. Lighting the Rear Rotisserie (Infrared) Burner:

- a) Read instructions before lighting.
- b) Turn all knobs to "OFF" then open the propane cylinder valve, Or the natural gas valve at the quick release.
- c) Always keep your face and body averted when lighting the grill.
- d) Open lid during lighting.
- e) Push and turn rear burner control knob to the "HIGH" position, then push and hold igniter button until burner lights. Up to 5 seconds is allowed for ignition.
- f) Follow match lighting instruction if burner can't be lit after repeating above steps 3-4 times.

TECH-TIP
Remove Warming Rack before using your rotisserie burner; otherwise the rack may be damaged due to excessive heat.

6. Lighting the Rear Rotisserie (Infrared) Burner by match:

- a) Read instructions before lighting.
- b) Open the lid during lighting.
- c) Push and turn the rear burner knobs slowly to "HI" position, then release.
- d) Light by match with left hand. Make sure the burner lights and stays lit.

Grill, Rotisserie & Side Burner Cooking:

Total Gas Consumption:

Total gas consumption per hour, per burner: **MODEL JPG700:**

Main burners:	15,000 Btu/hr.	X	4	=	60,000 BTU/hr.
Rear burners:	15,000 Btu/hr.	X	1	=	15,000 BTU/hr.
Side burner:	15,000 Btu/hr.	X	1	=	<u>15,000</u> BTU/hr.
Total Potential Consumption:				=	90,000 BTU/hr.

!WARNING!

Clean your grill often, especially the grease pan and grease cup. Failure to do so may cause a grease fire, resulting in injury or property damage!

■ SAFETY REMINDERS:

- Always leak test your grill before use.
- NEVER let children operate the grill or play near the grill.
- This grill is for outdoor use ONLY. NEVER use in an enclosed area like a carport, porch, covered patio, garage, or under a surface that can catch fire.
- Do not block the ventilation holes in the four sides of the grill cart, it may affect the combustion performance of the burner due to insufficient air.
- Use your grill at least 36" away from any wall or surface & 120" away from objects that may spark and ignite gas i.e. live electrical appliances, pilot lights of water heaters, etc.
- Do not use this grill on or under wood balconies.
- This grill is designed to use only propane (or natural gas if equipped with natural gas orifices). DO NOT use lava rock, briquettes, or charcoal with this grill.
- NEVER light the burner with lid closed. Non-ignited gas accumulated inside a closed grill may cause explosions.
- Check the burner flames periodically.
- Turn off the gas supply when the grill is not in use.
- Always turn off the propane cylinder completely and detach from the grill before moving.

■ FOOD SAFETY:

- Always adhere to the following tips to enjoy a safe and healthy outdoor grilling.
- Always use hot soapy water to wash hands, surfaces & utensils after processing raw meat.
- Always separate the raw meats from done foods to avoid cross contamination
- Always use clean utensils to handle the food.
- Always cook the meat thoroughly to kill germs. Use a thermometer to inspect the inner temp of the meat, if necessary.
- Place all foodstuffs promptly into refrigerator once the meal is over, to prevent spoiling.

1. General:

- a) The thickness of the meat will affect the grilling time and results; whether rare, medium, or well done.
- b) The pre-heated temperature of the grill affects grilling time and results.
- c) Defrost meat in the refrigerator overnight. Do not use a microwave, as this dries out the meat.
- d) For best results, use a metal spatula or tongs or a fork to turn the meat (not a fork).
- e) To get the juiciest meats, use appropriate cooking times and temperatures.
- f) Cut off any excess fat from the meat before grilling, as this will prevent flame flare ups.
- g) The hot grids sear the food, caramelizing it for optimal flavor. The longer your grill is the preheated, the faster the meat will sear.

2. Using the Grilling Surface (Cook Grids):

- a) Grilling requires high heat for searing and proper browning.
- b) Most foods are cooked at the "HI" heat setting for the entire cooking duration.
- c) When grilling large pieces of meat or poultry, it may be necessary to turn the heat to a lower setting, after the initial searing. This allows the food to cook through without burning the outside. Foods cooked for a long time or basted with a sugary marinade may need a lower heat setting near the end of the cooking time.
- d) Turn the control knob(s) to "Hi" and preheat the grill for 8 minutes. (Time may vary based on climate)
Note: Keep the grill closed during preheating.
- e) Place the food on the grill and cook to the desired doneness. Adjust heat setting, if necessary. The control knobs may be set to any position between "HI" and "LO".

!WARNING!

Do not leave grill unattended while cooking! Potential BURN and FIRE RISK!

3. Using the Rotisserie Kit:

- a) Take off the rotisserie kit (spit rod & forks assembly) from the grill.
- b) Loosen and slide the left fork off of the spit rod.
- c) Load the meat or poultry onto the spit rod; center the meat as much as possible.
- d) Re-install the left fork, then slide the two forks into the meat to secure.
- e) Center forks and meat on the spit rod, then tighten down the fork wing nuts
- f) If the meat has any loose portions, wrap the meat with butcher's string (never use nylon or plastic)
- g) Re-install the rotisserie kit into your grill, ensuring that the pointed end is fitted into the motor.

4. Tips for ROTISSERIE cooking:

- a) When using the rotisserie, the meat should be centered on the spit rod, after which it must be balanced. To balance the meat, first rotate the cut so that heaviest side is facing downwards. Next, position the counter balance so that it faces upwards. Secure in place by tightening the counter balance wing nut. Check the rotisserie function to ensure that the spit is rotating freely. It may be necessary to adjust the counter balance weight in or out, to achieve a smooth rotation.
- b) Place a drip pan on top of the upper flavor shields and position the pan directly beneath the food on the spit rod. Depending on the flavor you desire, place liquid in the pan such as, water, juices or wine, chop up onions or add garlic, As the juices fall from the meat they will mix with the liquid and evaporate directly into the meat, this removes the need for manual basting as this is a self-basting system.
- c) Do not let the drip tray dry out.
- d) You are now ready to rotisserie cook!
- e) Season meat or poultry as desired, then light the rotisserie burner (refer to instructions in this manual).
- f) Always use a meat thermometer to determine how well the meat is cooked. Insert the thermometer into the center of the meat. Do not allow the thermometer to touch a bone as this will not give an accurate reading on the meat thermometer. When checking poultry, the best location to insert the thermometer is in the center of the thigh muscle, next to the body.
- g) Close lid while cooking.

5. Using the Dual Zone Side Burner :

- a) **LIGHTING:** Push in and rotate the control knob counter clockwise slowly, to the "HI" position. (Rotate for a two second count). The built-in igniter will click and spark, lighting the torch-light pilot flame, then the main burner. If the burner does not light **IMMEDIATELY**, turn the knob to off and wait 5 minutes. Repeat lighting procedure.
- b) To use the simmer feature, turn the lit side burner down to its lowest setting. The center simmer burner will remain lit; this provides a low but steady heat for melting butter, simmering or keeping foods warm.



Cleaning and Maintenance:

CAUTION:

- Keep the grill area clear and free from combustible materials, gasoline and other flammable vapors and liquids
- Ensure that the grill is completely cold before performing any cleaning and maintenance.
- Burning off deposits and soiling by turning the main burners on high for about 5 minutes after each use will keep excessive food residue from building up, but this DOES NOT replace proper cleaning and maintenance.

1. General Info:

- This grill is made of stainless steel. There are many different stainless steel cleaners available. Always use the mildest cleaning method first, scrubbing in the direction of the grain.
- To touch up noticeable scratches in the stainless steel, sand very lightly with very fine emery cloth or 800 grit sandpaper, in the direction of the grain. Specks of grease can gather on the surfaces of the stainless steel and bake onto the surface, giving the appearance of rust.

Use a cleaning pad (such as ScotchBrite) along with a stainless steel cleaner to remove these stains. (Rub in the direction of the stainless grain.) Final finish with a stainless steel polish, using a soft, dry cloth.

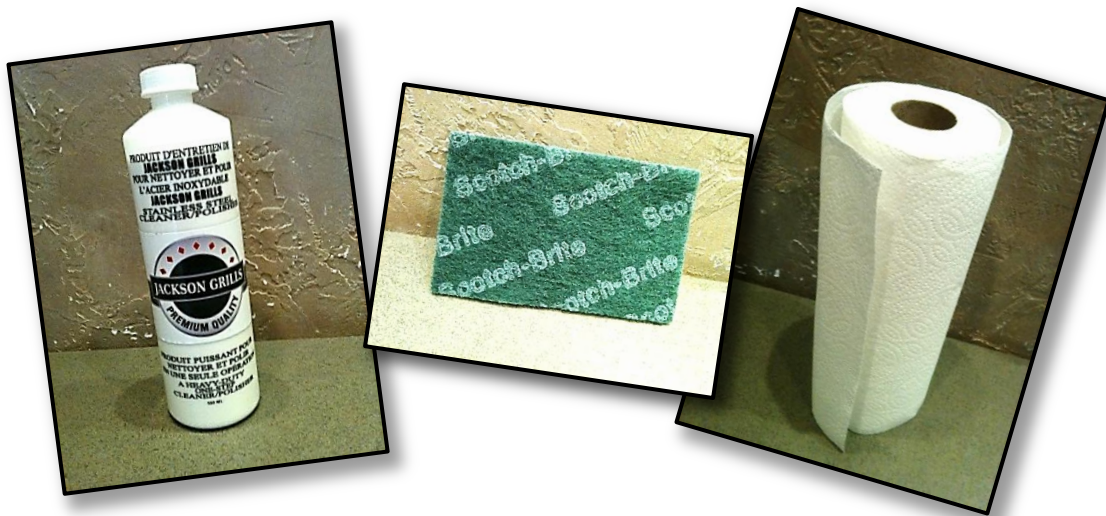

2. Grease Management System:

- Your grill is equipped with a small grease cup in the back of the unit. This cup should be emptied & cleaned thoroughly after each use and before the grill is transported.
- Your grill is designed to allow grease to flow along the bottom of the firebox, and collect in both the grease collecting pan and the small grease cup. (See photos next page).

!WARNING!

Clean your grease pan AND grease cup regularly. Failure to do so may cause a grease fire, resulting in injury or property damage!

- Both the grease pan and the cup must be cleaned on a regular basis, for the system to work as designed, and prevent grease fires.
- A small amount of sand can be added to the grease pan and cup for absorbing accumulated grease.



3. Cooking Grid Cleaning:

- If the grids are heavily soiled, turn your main burners on high for 10 minutes to burn off excess deposits. (Do NOT run the rotisserie burner with the main burners).
- After each grilling session, clean the cooking grids with a stainless or brass wire barbecue brush. The best method is to clean immediately after cooking, while the grill is still hot. Wear a barbecue mitt to protect your hand from heat and steam. Dip your brush frequently in tap water and scrub the hot grill. Steam created by the hot grill assists the cleaning process by softening deposits. The food particles will fall off and be burn up later. Never immerse ANY hot parts in water.
- For final cleaning, the cooking surface can be washed with hot soapy water, utilizing a Scotch Brite scouring pad for stubborn deposits.

TECH-TIP

Do NOT turn on the rotisserie burner when the main burners are being used to clean the grill; otherwise overheat damage to your barbecue may result.

4. Exterior Surface Cleaning:

- Use mild dish soap and hot water to clean the outside of the grill.
- Do not use any abrasive cleaners, scouring pads, strong degreasers etc., on the exterior of this grill; this will scratch the stainless finish.
- If using the Jackson Stainless Steel Cleaner to remove any surface corrosion be sure to go with the grain of the finish in order to not make swirls in the stainless steel, this product is mildly abrasive and is should be applied with a soft cloth.

TECH-TIP

Some cleaners may remove the silk screened labels on the console; use caution when cleaning the console.

TECH-TIP

When cleaning heavy soiling, always polish or scrub in the direction of the stainless steel grain.

- Specks of grease can adhere to the surfaces of the stainless steel and bake on; this will give the appearance of rust. Use an abrasive pad with stainless steel cleaner to remove.
- Sand heavy scratches lightly with 600 grit wet and dry sandpaper.
- Always rinse with clean hot water.
- Use a spray polish on stainless steel polish to add shine and help protect the exterior stainless steel from surface contaminants and any corrosion.

5. Interior Firebox Cleaning:

- Remove the cooking grid, flame diffuser and the burner from the grill.
- Remove excess residue using a brush, scraper and/or cleaning pad.
- Spray inside the firebox with oven degreaser and let stand for 5 minutes.
- Use a toothbrush to loosen up grease and food residues.
- Wash with soapy water, and rinse with clean hot water.
- Wipe out firebox with a paper towel or rag.
- Leave lid open to allow the grill to air dry.

TECH-TIP

Many cleaners can be caustic, so for final cleaning use soapy hot water followed by a rinse with clean hot water.

6. Main Burner cleaning & maintenance:

- Check to ensure that all gas knobs and valves are off.
- Remove burners and inspect inner and outer surfaces for contamination and debris.
- Clean the exterior burner surface with a stiff stainless steel grill brush.
- Make sure all of the burner port holes are free of obstruction by using a large paperclip to poke the holes out. This is **extremely important** to prolong the lifespan of the stainless steel burner.

7. Flame diffuser maintenance:

- Remove residue and larger pieces of food using a brush, scraper and or cleaning pad after each use.
- If desired, cleaners can be used for the final cleaning; then rinse with clean hot water.
- This will reduce flare ups and prevent premature break down.

!WARNING!

When reinstalling the main burners after cleaning, the burners must be positioned so that orifices of the valves are inserted into the center of each burner. Failure to do so could cause flames to escape around the burner inlets, which may result in damage or injury.

Grill Storage:

- Clean your grill thoroughly before storage as this will result in greater longevity.
- When propane cylinder is left connected, store the grill outdoors and out of reach of children.
- Store the grill in a dry indoor location **ONLY** after the propane cylinder is turned off and removed.
- All propane cylinder must be stored outdoors, out of the reach of children. **NEVER** store the cylinder in a building, garage or any other enclosed area.
- Always store your grill with supplied cover installed.

Trouble Shooting:

A) SPIDER AND INSECT WARNING:

Spiders and insects can nest in the burners during storage: these nests can cause fires inside burners or beneath the grill. This is potentially hazardous: ALWAYS remove and clean the burners immediately after bringing your grill out of storage, and regularly thereafter.

B) When to Inspect Your Burners:

Inspect the burners each time you use your grill, or immediately if any of the following conditions occur:

1. Yellow flames with burnt insect odor.
2. Temperature too low or heats unevenly
3. The burners make popping noises.

PROBLEMS	POSSIBLE CAUSE	SOLUTIONS
Torch Light pilot flame will not light	Electrode deposited with cooking residues	Use clean swab and alcohol to clean.
	Electrode or wire damaged & no spark	Replace gas valve assembly
	Electrode wire loose or fallen off	Reconnect electrode wire at gas valve
	Plugged Torch Light orifice	Unplug orifice
	Pilot outlet tube (flame tube) blocked	Check & clean tube of insects, nests, & debris.
Main Burner won't light after torch light lights successfully.	Burner orifices plugged/caked with residue.	Check and clean burners
	Valve not delivering fuel (no gas flow)	Check that gas is turned on. If only one burner is affected, replace one burner valve
	Air Shutters set incorrectly	Re-set burner air shutters per owner's manual.
	Burner incorrectly installed and misaligned with valve orifice	Re-install burner correctly so that the orifice is centered in the burner's inlet.
	Gas flow is intermittent	Clean/clear burners and main orifices
No Spark at rear burner	Dead battery in rear burner igniter switch	Replace battery by unscrewing switch cap
Inadequate Heat	Incorrect burner orifice size	Replace orifices and/or set shutter to match gas type. (LP or Nat Gas)
	Air Shutters set incorrectly	Re-set burner air shutters per owner's manual.
Gas valve hard to turn Yellow or orange flame with gas odor	Corrosion at valve stem	Remove knob and lube with penetrating oil
	Incomplete combustion	Call your local dealer.
Low heat with knob in "HI" position.	Gas hose bent or kinked	Smooth out the hose.
Yellow or orange flame with gas odor	Burner or orifice blocked.	Clear blockage.
Low heat with knob in "HI" position. Flame Flare-ups	Low gas pressure	Call the gas dealer. (Check propane cylinder may be nearing empty.)
	Grill not preheated	Preheat the grill for 15 minutes.
	Excessive fat on meats	Cut off fat before grilling.
	Temperature too high	Adjust
Flame Flare-ups Flame out Flame lifting	Excess Grease deposits	Clean
	High winds	Turn up flames; keep watch so it does not go out.
	Too high of a gas pressure	Call the gas dealer.
Flame out	Air Shutters set incorrectly	Re-set burner air shutters per owner's manual.
Flashback Grease fire	Burner inlet blocked with debris	Remove burner and clean inlet
	Grease accumulated in grease tray & cup due to improper cleaning & maintenance.	Regularly inspect and clean grease pan and cup to prevent grease accumulation.

Exploded View: JPG700 Cart

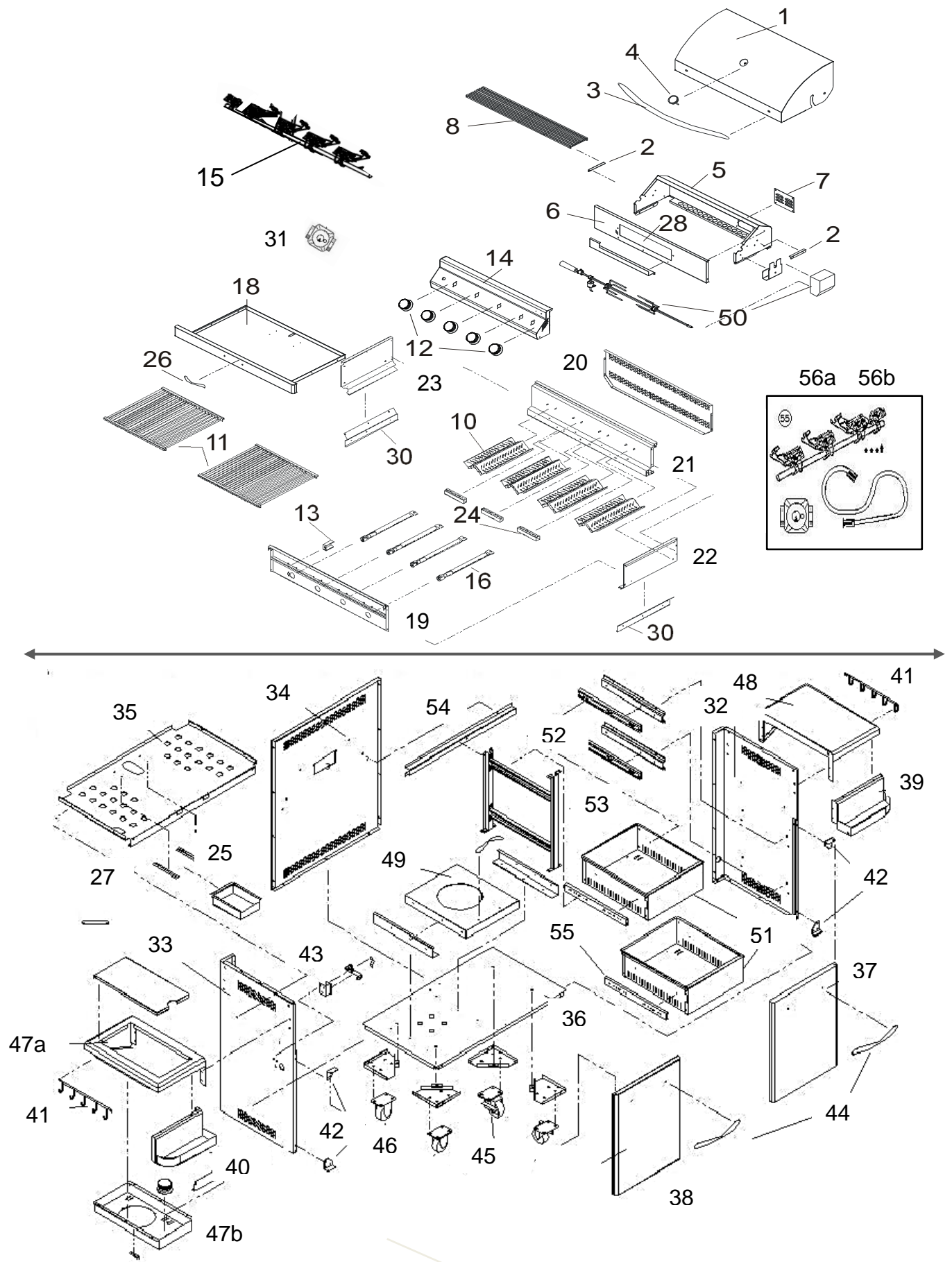

Parts List: JPG700 Cart

Loc.	DESCRIPTION	Part# (Qty.)	Loc.	DESCRIPTION	Part# (Qty.)
01	Hood	JH-004	32	Pedestal Side Right	JC-92
02	Warming Shelf Rail	JH-102 (2)	33	Pedestal Side Left	JC-93
03	Hood Handle	JH-92	34	Pedestal Back Panel	JC-94
04	Thermometer	JT-04	35	Pedestal Heat Shield	JC-95
05	Inner Hood	JH-007	36	Pedestal Base	JC-96
06	Rotisserie Burner Mount Panel	JR-40	37	Pedestal Right Door	JC-97
07	Rotiss Orifice Access Plate	JR-42	38	Pedestal Left Door	JC-98
08	Warming Shelf	JG-49	39	Right Condiment Bin	JC-48
09	*Rotisserie Collector Box	JE-27	40	Left Condiment Bin	JC-47
10	Diffuser	JD-08 (4)	41	Utensil Holder	JC-01 (2)
11	Cook Grid	JG-16 (2)	42	Door Hinge	JC-02 (2)
12	Knob	JK-07 (5)	43	*Gas Manifold Bracket & Fitting	JF-002
13	Ignition Module Rotisserie	JE-00	44	Door Handle	JC-03 (2)
14	Front Console	JH-58	45	Swivel Caster (Locking)	JC-04 (2)
15A	Manifold Complete: Natural Gas	JF-73	46	Swivel Caster (Non-Lock)	JC-05 (2)
15B	Manifold Complete: Propane	JF-79	47A	Side Shelf Left	JC-06
16	Main Burner	JB-00 (4)	47B	Side Burner Assembly	JB-24
17	*Manifold (bare)	JF-87	48	Side Shelf Right	JC-07
18	Grease Tray	JH-40	49	Tank Slide Out Assembly	JC-99
19	Firebox Front	Call Dealer	50	Rotisserie Kit	JR-43
20	Firebox Rear Cover	Call Dealer	51	Drawer	JC-44 (2)
21	Firebox Rear	Call Dealer	52	Drawer Glide Right (one set)	JH-39 (4)
22	Firebox Left Side	Call Dealer	53	Inner Drawer Support Frame	JC-46
23	Firebox Right Side	Call Dealer	54	Horizontal Support Frame Rear	JC-71
24	Cross-lighter	JH-11 (3)	55	Drawer Glide (one set)	See #52
26	Grease Tray Handle	JH-008	56a	NG Conversion Kit	JF-78
27	Grease Cup Rail (set)	JH-79	56b	LP Conversion Kit	JF-001
28	Rotisserie Burner	JB-14		*Rotisserie Motor	JR-06
29	Rear Burner Orifice	n/a		*Electrode: Rotisserie	JE-17
30	Grease Pan Friction Rails	JH-51		*Fork Kit: Rotiss. w/ Loop Balancer	JR-18
31	Regulator Nat Gas 4.5" WC	JF-99		*Spit Rod: Rotisserie	JR-21
*Not Shown					

Limited Lifetime Warranty:

MODEL NO: JPG700

Jackson Grills Inc. warrants the following materials and workmanship to be free of defects for as long as you own the grill subject to the conditions below:

First 5 years: (from date of purchase); Jackson Grills will replace or repair (at our option), any defective part in the list below, at no charge

6 years to Lifetime: Jackson Grills will provide replacement parts at 50% of the current retail price.

- Stainless steel inner & outer hood
- Outer pedestal system
- Stainless steel handle
- Stainless steel burners,
- Firebox
- Flame diffusers
- Stainless steel cooking grids
- Warming shelf

Jackson Grills Inc. warrants the following materials and workmanship for 2 years:

2 Year Warranty: (from date of purchase); Jackson Grills will replace or repair (at our option), any defective part from the list below, at no charge.

- LP hose and regulator
- Thermometer
- Gas valves
- Knobs & fasteners
- Igniter and electrode
- Accessory parts (excluding covers)

NOTE; Grill covers are NOT WARRANTED

Limited Warranty Subject to the following Conditions & Limitations:

(NOTE: Shipping and Labor Charges are NOT covered)

- The bill of sale (proof of original ownership) and serial number will be required in order to claim warranty from your authorized dealer. The warranty registration card must be returned within 30 days to register your warranty.
- This factory warranty is non-transferable and may not be extended under any circumstances.
- Jackson Grills Inc. warrants its products to the original purchaser only (NO EXCEPTIONS)
- This Limited Warranty does not cover any damage caused by misuse, lack of maintenance, hostile environments, accident, alterations, abuse or neglect, including scratches, dents, corrosion, or discoloring by heat (all stainless steel will discolor), and abrasive or chemical damage resulting from use of harsh cleaners.
- Should deterioration occur to the point of non-performance within the duration of the warranted coverage, a replacement will be provided in the first year only. This warranty extends to the repair or replacement of warranted parts that are defective in materials or workmanship provided that the product has been operated in accordance with the operation instructions and under normal conditions.
- After the first year Jackson Grills Inc. reserves the right to fully disengage all obligations with respect to this Limited Warranty by refunding the original warranted purchaser the original wholesale price of the warranted parts.
- A licensed, authorized, service technician or contractor must install the gas grill.
- Genuine Jackson parts must always be used; use of parts supplied by other manufacturers will nullify the warranty.
- The installation must be done in accordance with the installation procedures described in the included owner's manual.
- Jackson Grills Inc. or its parties will not be responsible for the installation, labor or any other costs or expenses related to the refitting of the warranted part, and such expenses are not covered by this warranty.
- Notwithstanding any provision contained in this Limited Warranty, Jackson Grills Inc. responsibility under this warranty is defined as above and it shall not in any event extend to any incidental, consequential, or indirect damages.
- Jackson Grills Inc. neither assumes, nor authorizes any third party to assume, on its behalf, any other liabilities with respect to the sale of this product.
- Jackson Grills Inc. reserves the right to inspect any parts prior to approving warranty claim.
- Jackson Grills or its representatives shall not be liable for ANY shipping charges, labor charges or duties.